

Introduction

Thank you for purchasing our faucet. The faucet you have purchased is crafted out of the highest quality nickel, brass and stainless steel. Each and every faucet was tested and carefully inspected by hand before delivering to our retailers.

Please read the instructions carefully to prevent any malfunction and damages to your plumbing and property.

Tools

The tools below are required to complete the installation. Some may not be needed depending on the model of the faucet that you are installing. For additional information, check with your local hardware store on the requirements for your installation. **(NOT PROVIDED)**



Phillips Screwdriver



Thread Seal Tape



Flashlight



Pliers



Adjustable Wrench



Safety Glasses

Specification

- Lever style handle with temperature indicator on the escutcheon
- Handle operates upward through a 23° arc. The rotation angle of temperature is 100°. Maximum hot through 50° in clockwise direction. Minimum cold through 50° in counterclockwise.
- Adjustable temperature limit stop to control maximum hot water temperature.
- Pressure balancing mechanism maintains selected discharge temperature to $\pm 3.6^\circ\text{F}$ ($\pm 2^\circ\text{C}$)

Daily maintenance

- Dip the cloth into mixture of white vinegar and water (50/50) and scrub to remove hard-water spots.
- Check aerator (if present) regularly for calcium build up and when water stream is not optimum.
- DO NOT use caustic cleaning products as the use will break down finish and will void the product warranty.
- Acceptable cleaners include mixture of white vinegar and water (50/50) or mild non-abrasive liquid detergents.
- If the water pressure appears to be less than optimum remove, inspect, clean or replace aerator.

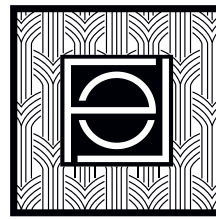

Shower Room Faucet

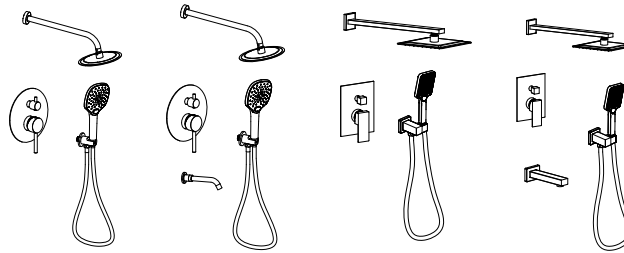

FAS-9001 FAS-9002 FAS-9003 FAS-9004

Mounting Depth

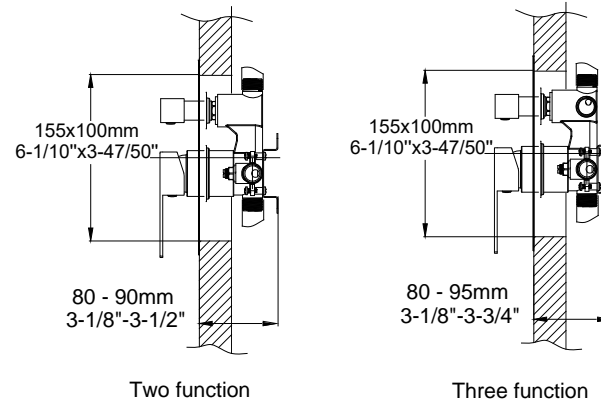

Before you begin

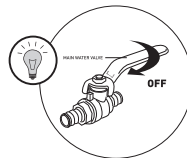

Helpful Hint:

Always use the supplied rubber washers on water supply connectors to prevent leaking. Also, always use an adequate amount of plumber's putty or thread sealing tape to prevent connectors from leaking.



Notice

Notes before installation :

- Please check that all components are present.
- Before installation ensure that all feed lines are clear of debris and on/off valve is present.
- Ensure water pressure is between 20-125 PSI (includes combination of hot and cold feed lines).
- Pictures in the manual are general in content and may not represent exactly your purchased faucet. If you are having difficulties please contact a professional plumber.
- If you will be away from home for an extended period you should shut off the main water.
- Rinse all water pipes before installation to insure no impurities remain inside.
- When welding the shower valve to the water pipe, take out the cartridge and any seals in the valve. When welding is complete, wait for body of the valve to cool down, then re-install the cartridge and the seal parts.
- A force of 11-13 N.m is needed to securely lock the cartridge.
- All valves have to pass air and pressure testing before shipment. If you wish to request pressure testing before installation, it must be through a professionally licensed plumber and air pressure must not exceed 125 PSI.

Warranty

The warranty does not apply to the following cases:

- Failure to provide purchase receipt.
- Material damage caused by carelessness or during transport.
- Due to improper installation.
- Alterations or repairs by un-authorized persons.
- Damaged of the nickel plating because of unauthorized cleaning methods (hard and heavy detergent).

ACCESSORIES CATEGORY	WARRANTY PERIOD (FUNCTION, APPEARANCE)
CARTRIDGE	SHOWER SET (THERMOSTATIC, HOT & COLD) 2 YEARS
	BATHTUB FAUCET/POTFILLER 2 YEARS
	BASIN/KITCHEN FAUCET 5 YEARS
SHOWER/KITCHEN FAUCET TUBE	1 YEAR
SHOWER HOSE	1 YEAR
KITCHEN FAUCET SPOUT	1 YEAR
SHOWER HEAD, HAND SHOWER	1 YEAR
SHOWER/KITCHEN/BASIN MIXER BODY (CHROME COLOR)	5 YEARS
SHOWER/KITCHEN/BASIN MIXER BODY (BRUSH NICKEL, MATTE BLACK, BRUSH GOLD, GUN BLACK)	2 YEARS

Two Functions Concealed Shower Installation

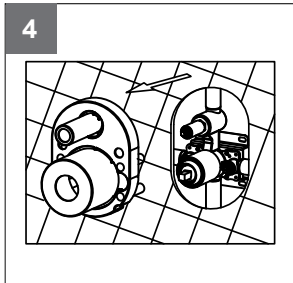
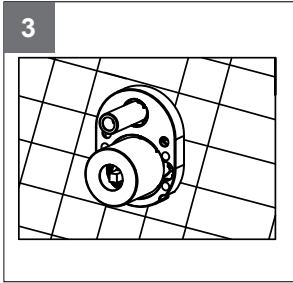
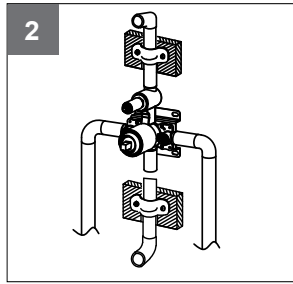
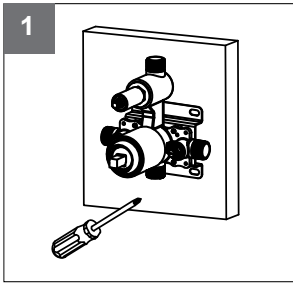

Three Functions Concealed Shower Installation

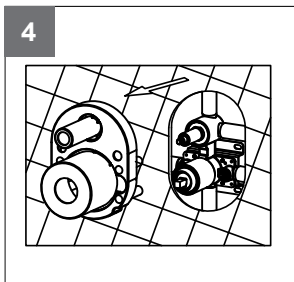
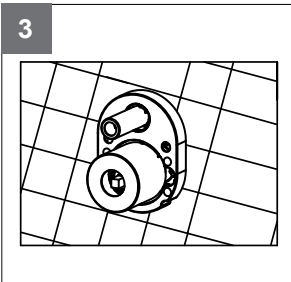
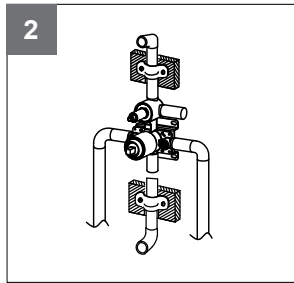
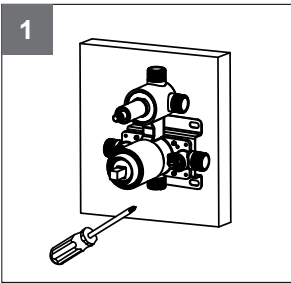

Shower Trims Installation steps

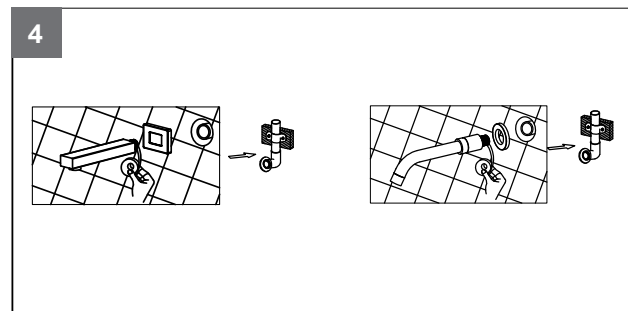
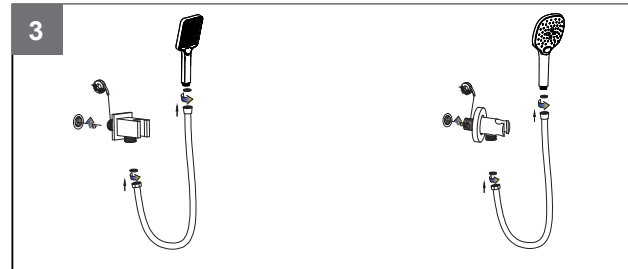
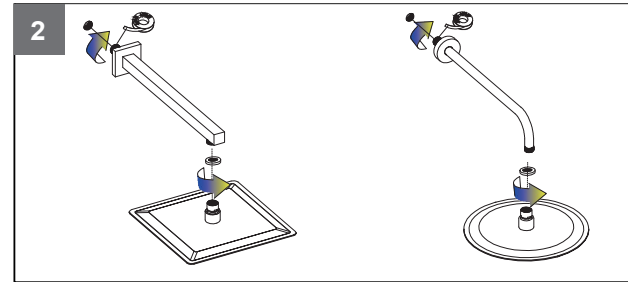
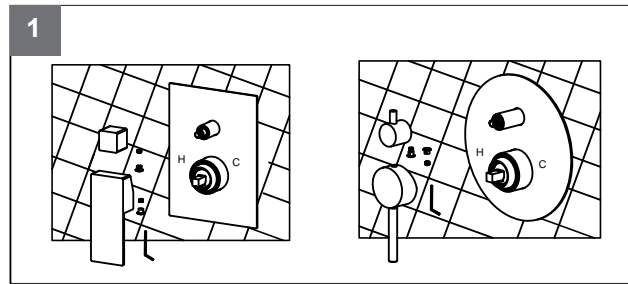

Testing

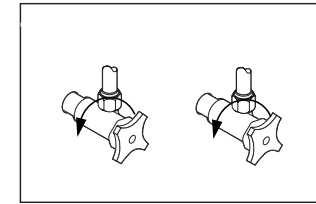

Turn on water supplies and check all connections for leaks. If there are leaks, turn off water supplies and check to see if proper washers were used along with proper thread sealing tape.

Troubleshooting

Problem	Possible Cause	Corrective Action
Water does not shut off completely.	1. O-ring is not seated correctly or worn. 2. Cartridge may be defective.	1. Reseat or replace O-ring. 2. Replace cartridge
Leaks at waterline connection.	1. Worn or broken washer.	1. Replace washer.
Leaks from handle.	1. Cartridge may come loose. 2. Cartridge may be defective.	1. Reseat cartridge tight. 2. Replace cartridge.
Leaks at hose connection.	1. Hose connection is loose.	1. Tighten hose. 2. Replace hose.
Leaks at shower valve connection	1. Connection may come loose or not sealed completely 2. Defective shower valve inlet or outlet connector.	1. Check connections. 2. Replace valve body.
Diverter knob does not work	1. Diverter cartridge may be defective.	1. Replace cartridge.
Low flow	1. Check for water pressure problems. 2. Aerator may be dirty or clogged.	1. Clean or replace the aerator. 2. Remove water flow restrictor if available. 3. Install booster or pump (if applicable).

Accessories parts if need

